

Gebrauchsanleitung PK-Nr. 3011

Instructions / Mode d'emploi / Gebruiksaanwijzing /
инструкция по использованию

PAIDI Möbel GmbH
Hauptstraße 87
D-97840 Hafenlohr



www.blauer-engel.de/uz38
• emissionsarm
• Holz aus nachhaltiger Forstwirtschaft
• in der Wohnumwelt gesundheitlich unbedenklich



1:1
DIN A3

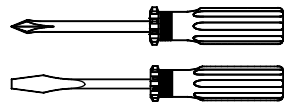
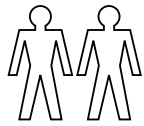
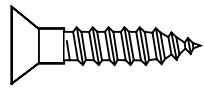

ca. 0,5h

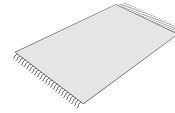

A 3x 681 2793	B 3x 681 2584	C 1x 681 8503	D 4,0 x 40 2x 681 4911	Z 3x 681 2552
--------------------------------	--------------------------------	--------------------------------	--	--------------------------------

OSCAR
235 7014
235 7015

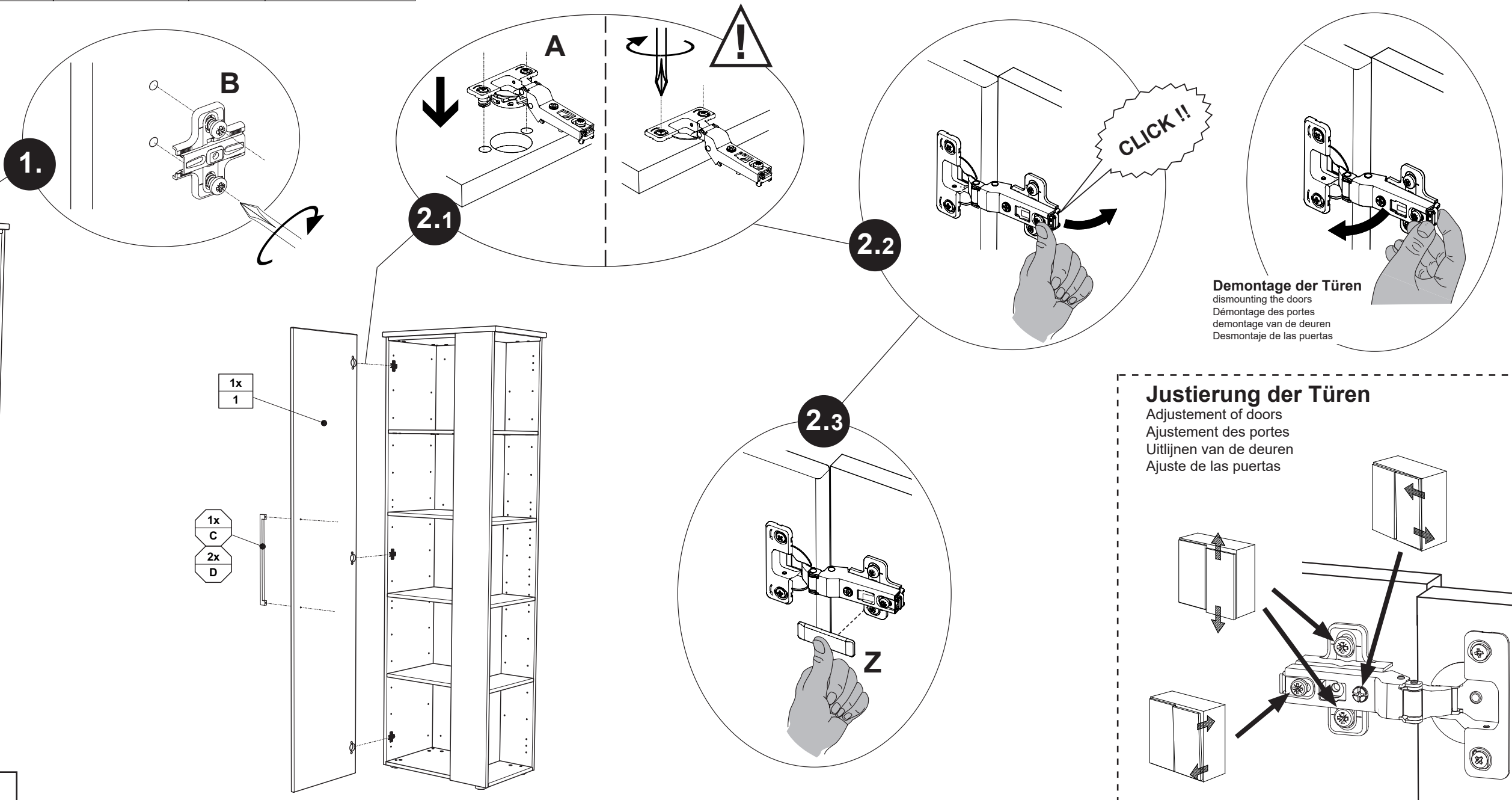
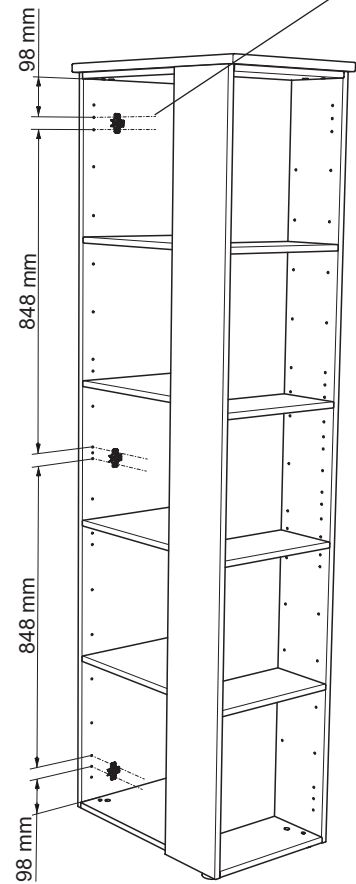
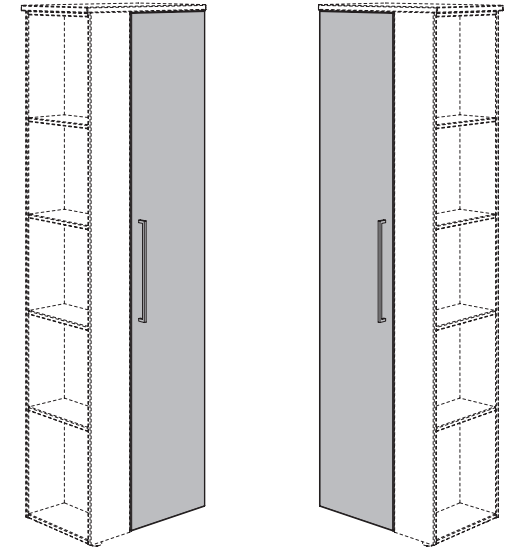

Demontage der Türen
dismounting the doors
Démontage des portes
demontage van de deuren
Desmontaje de las puertas

Justierung der Türen

Adjustement of doors
Ajustement des portes
Uitlijnen van de deuren
Ajuste de las puertas

